

Kunai

Design & Diagrams by Gerwin Sturm (2006/11/25)

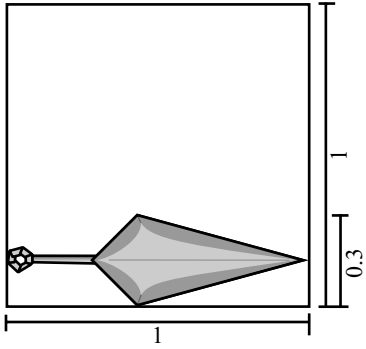

For all those Narutards and all others who want to play Ninja, here's the model for you.

I would recommend a 15 cm square of silver Japanese foil for this model, which will give a realistic looking Kunai about 15 cm long. Unfortunately this model won't fly very well when thrown.

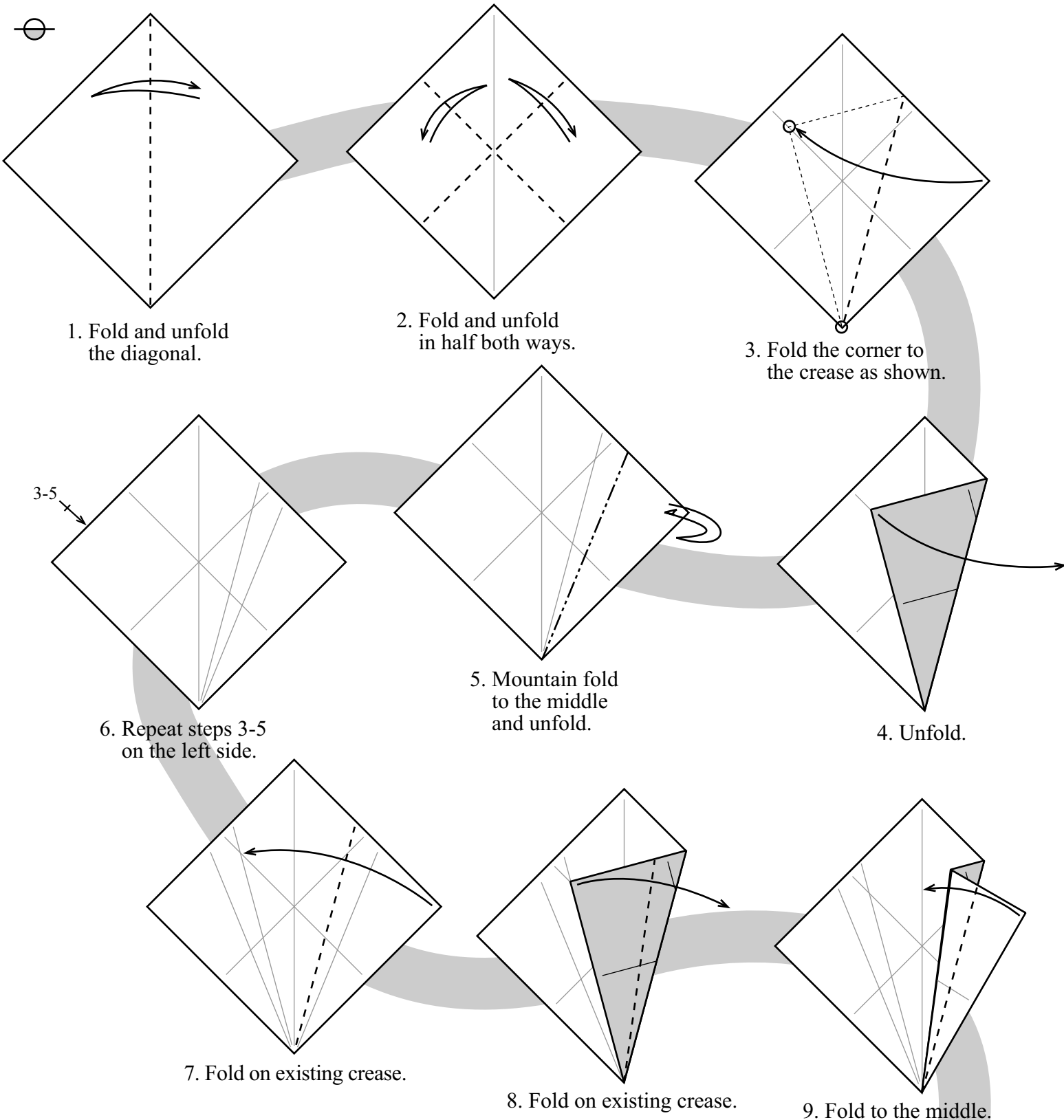

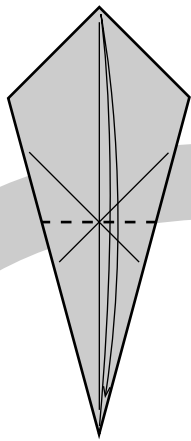

12. Fold corner to corner and unfold.

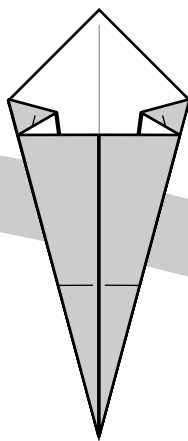

11. Turn over.

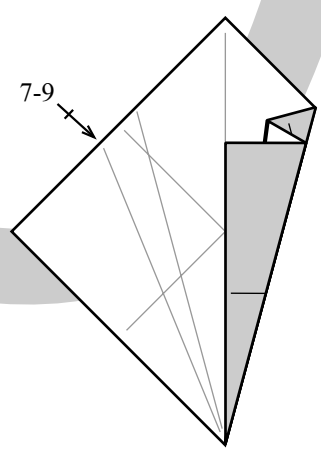

10. Repeat steps 7-9 on the left side.

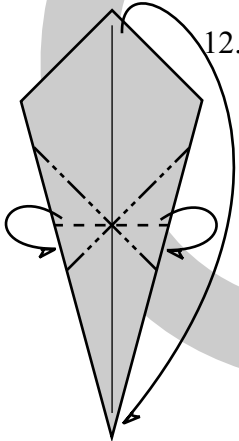

13. Form a kind of preliminary base using existing creases.

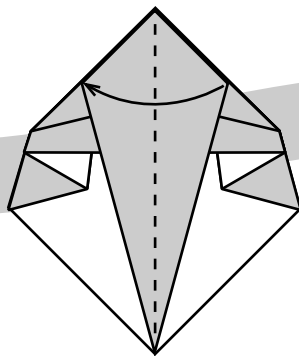

14. Fold one flap to the left.

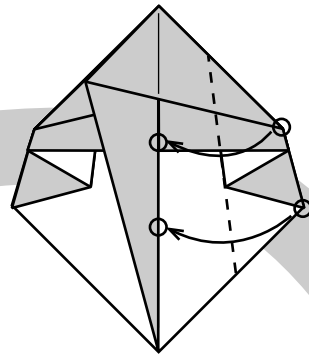

15. Fold the edge to the middle.

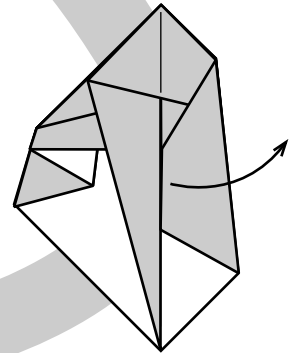

16. Like this. Unfold.

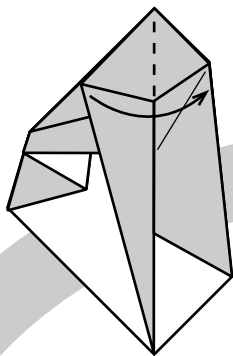

18. Fold one flap to the right.

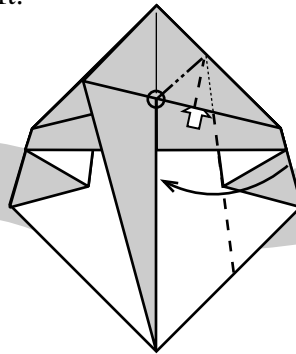

17. Swivel as shown, using the existing crease.

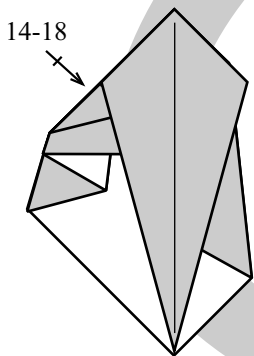

19. Repeat steps 14-18 on the left side.

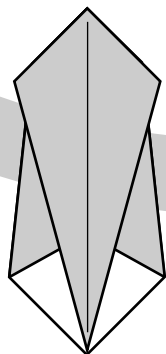

20. Turn over.

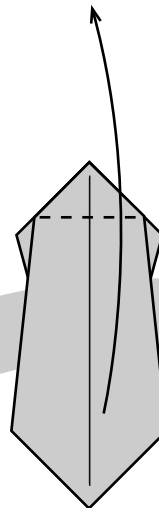

21. Fold up as far as possible.

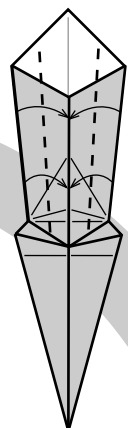

22. Fold the sides to the middle.

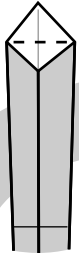

26. Fold the tip down.

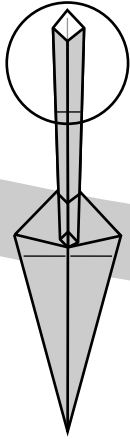

25. Focus on the top part.

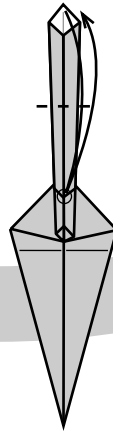

24. Fold the top corner to the circled point and unfold.

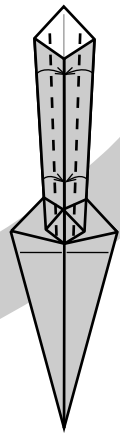

23. Fold the sides to the middle.

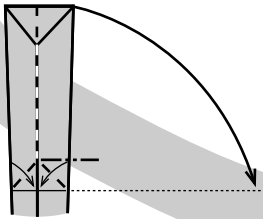

27. Rabbit ear the flap down to the existing crease.

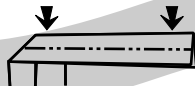

28. Open sink the flap in half.

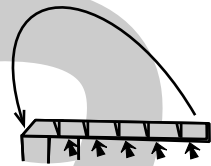

29. Form a ring with a series of tiny crimps and/or reverse folds.



30. It should look somehow like this. Zooming out.

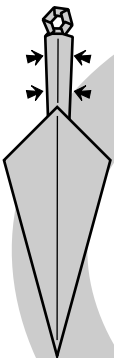

31. Turn over.

32. Thin and round the handle.

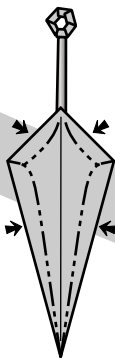

33. Shape the blade with soft mountain folds.



34. The finished Kunai.